

S T U F E A L E G N A

SERIE X



RIZZOLI[®]

FIRE SINCE 1912

Un secolo di storia. La nostra.

Quando nel 1912 il fondatore Carlo Rizzoli iniziò a lavorare come fabbro magnano alle pendici delle Dolomiti, nessuno avrebbe mai immaginato a cosa quelle abili mani avrebbero portato.

Oggi, a distanza di oltre un secolo, Rizzoli produce e commercializza prodotti in tutta Europa e nel mondo. Nel tempo Rizzoli ha aggiunto alla abilità artigiana l'impiego delle migliori tecnologie e dei migliori materiali.

Questa è in sintesi la nostra storia.





Immersi in un parco naturale

L'headquarter dell'azienda da 25.000 m2 si trova a oltre 1000 metri sul livello del mare e all'interno del Parco Naturale Monte Corno, un'area protetta di oltre 6000 ettari incastonata nello splendido scenario delle Dolomiti alto atesine. A pochi chilometri di distanza dalla sede si trovano gruppi montuosi di straordinaria bellezza quali Latemar, Catinaccio, Sciliar e il geoparco Bletterbach, tutti inseriti nell'elenco dell'Unesco, patrimonio dell'umanità.





Materie prime

Quando progettiamo un prodotto, pensiamo a chi lo userà. Per questo selezioniamo con cura le materie prime, ottimizziamo i processi, testiamo le funzionalità e studiamo l'estetica. Se tutto ci soddisfa, facciamo ancora qualcosa in più.



Esperienza

Il tempo ci ha permesso di maturare l'esperienza che oggi, unita all'utilizzo delle più moderne tecnologie, ci rende un marchio conosciuto per l'alta qualità e l'affidabilità dei nostri prodotti, fatti come una volta ma perfetti per il presente.



Artigianalità

In Rizzoli non esiste la catena di montaggio, ma ogni addetto assembla completamente il prodotto dall'inizio alla fine, per garantire i più elevati standard qualitativi.



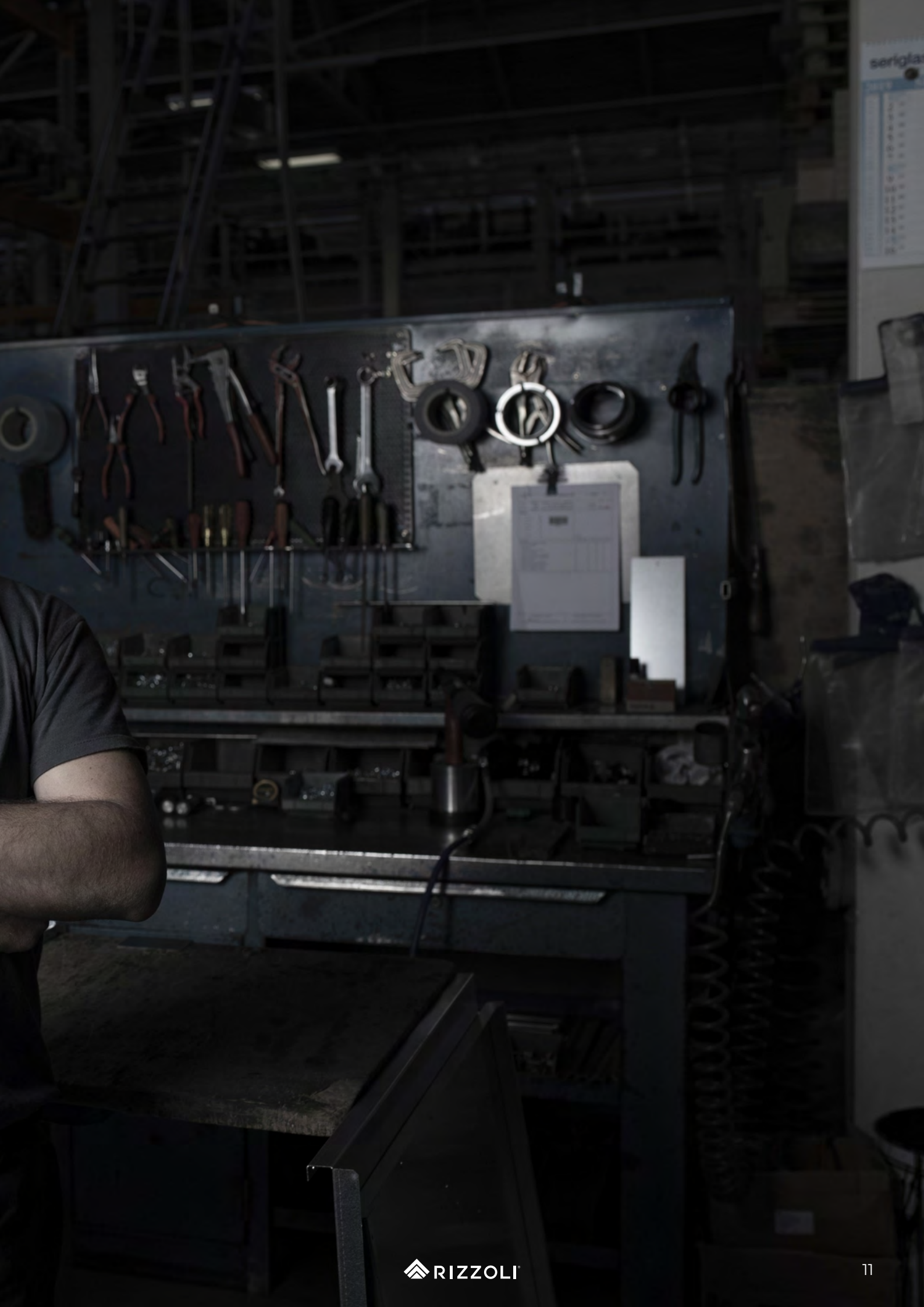

Tecnologia

Per noi l'innovazione non è un obiettivo da raggiungere: è un metodo di lavoro. Ogni anno investiamo buona parte delle nostre risorse in Ricerca & Sviluppo perché sappiamo che migliorare è l'unico modo per continuare a offrire un prodotto di riconosciuta qualità.







Serie X. Qualità a 5 stelle.

Quando abbiamo progettato questa stufa a legna volevamo un prodotto capace di stupire al primo sguardo, dove il fuoco tornasse ad essere il protagonista assoluto e dove il calore sprigionato potesse durare più a lungo possibile. Una stufa versatile, moderna, costruita con materiali solidi e di pregio, una stufa concepita per riscaldare in modo sano ed ecologico. Una stufa unica e irripetibile. E' nata così la Serie X, una linea di stufe a legna di ultima generazione che racchiude tutta la centenaria esperienza Rizzoli nel campo del riscaldamento a legna.

Qualità senza compromessi



CARATTERISTICHE PRINCIPALI

Autonomia



La camera di combustione permette grandi carichi di legna con un consumo di 2 kg/h.

Design

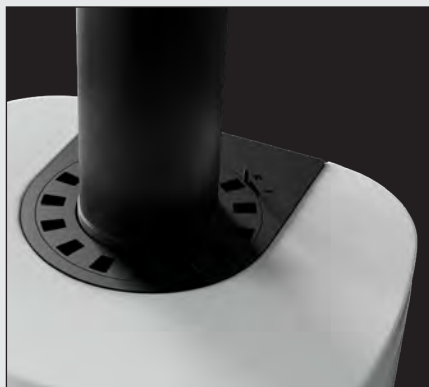

Il design della Serie X si caratterizza di linee moderne ed essenziali che ne esaltano lo stile.

Vermiculite



La camera di combustione è composta da vermiculite ad alta densità (850 kg/m³).

Sicurezza

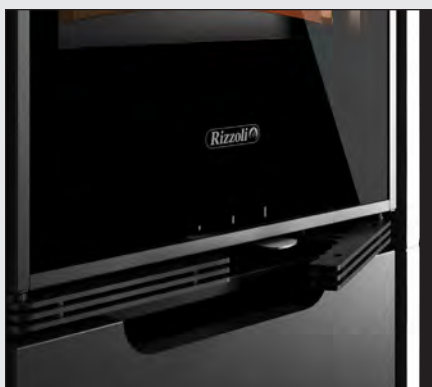

La porta fuoco ha una chiusura automatica di sicurezza comandata da una maniglia ergonomica isolata.

Visione del fuoco

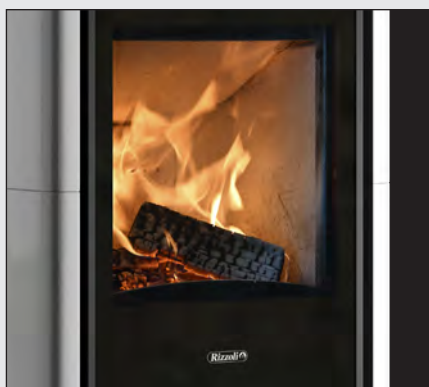

Il vetro ceramico con sistema autopulente regala una visione sul fuoco sempre unica e perfetta.

Corpo ermetico



Il cuore della Serie X è composto da una camera di combustione ermetica ed altamente efficiente.

Presenza aria



La presa d'aria External Air®, permette l'utilizzo di aria proveniente dall'esterno ideale per case passive.

Controllo aria



Un'unica leva di controllo per gestire in modo facile e preciso la combustione.

Facile pulizia



La graticola cenere rotante e il cassetto raccogli cenere, facilitano la pulizia ordinaria della stufa.

Serie X Basic



Una vista sul fuoco davvero unica

La Serie X Basic è la stufa a legna in versione base con ampia camera di combustione e vano porta legna. La stufa, dalle linee moderne ed essenziali, è costruita con materie prime di altissimo livello, moderne tecnologie e cura artigianale dei dettagli.



Serie X Basic

STUFE A LEGNA



X Line Basic



Misure (LxPxH)
534x464x1145 mm

   
175 9,5 12,0 15 PP

- Acciaio verniciato Nero
- Sportello inferiore (optional)



X Rock Basic



Misure (LxPxH)
550x462x1163 mm

   
275 9,5 12,0 15 PP

- Pietra Naturale
- Sportello inferiore (optional)

Serie X Basic

STUFE A LEGNA



X Art Basic



Misure (LxPxH)

600x476x1173 mm



240 9,5 12,0 15 PP

- Maiolica
- Sportello inferiore (optional)

Valori contributo Conto termico 2.0.
Riscaldamento a legna. Fonte di grande risparmio.

Modello	kW	A	B	C	D	E	F
X BASIC	9,5 kW	543,01 €	769,27 €	995,52 €	1267,03 €	1538,53 €	1629,03 €

Finiture: pag. 38
Area tecnica: pag. 44

Tecnologie:



Serie X Plus



La scorta di calore che desideravi

Grazie alla grande quantità di materiale refrattario aggiuntivo (kit optional da 70 kg), la versione Plus della Serie X garantisce molte ore di piacevole calore anche dopo lo spegnimento della fiamma. Il sistema prevede l'installazione di tre speciali anelli accumulatori installati immediatamente sopra la camera di combustione della stufa a legna e realizzati in Durasic®.



IL SISTEMA DURASIC®

Gli anelli accumulatori della Serie X Plus sono realizzati in Durasic®, straordinario e innovativo materiale composto da carburo di silicio e speciali argille refrattarie con alta resistenza agli shock termici e meccanici. La combinazione dei due elementi esclusivamente di origine naturale, ha dato vita ad un composto dalle eccellenti prestazioni

senza eguali nell'attuale mercato delle stufe ad accumulo. Il risultato è un rapido ed elevato accumulo del calore che verrà rilasciato nell'ambiente in maniera lenta e graduale. Questo rilascio sarà ancora più lungo nel modello X Art rivestito da 97 kg di maiolica e ancora di più nel modello X Rock rivestito con ben 126 kg di pietra naturale.

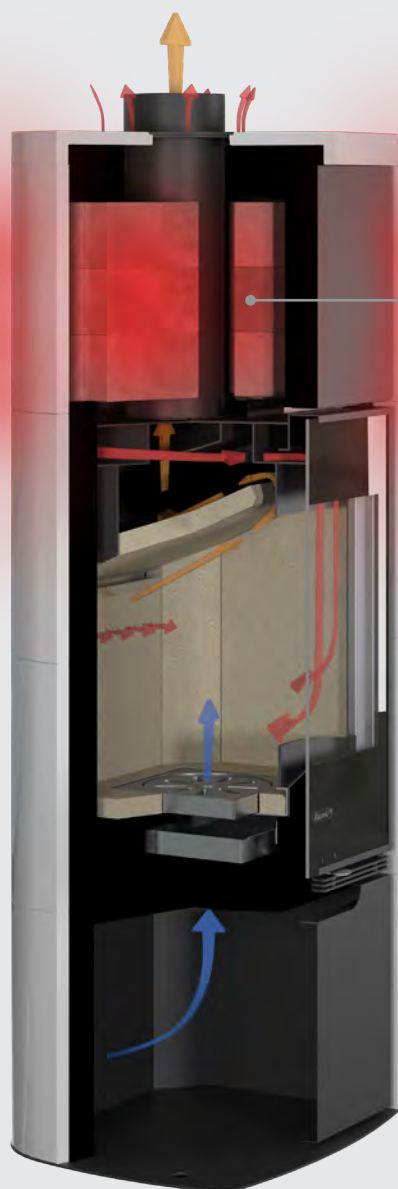

Anelli accumulatori di calore in Durasic® 70 kg.

DISTRIBUZIONE DEL CALORE NEL TEMPO CON IL SISTEMA DURASIC®

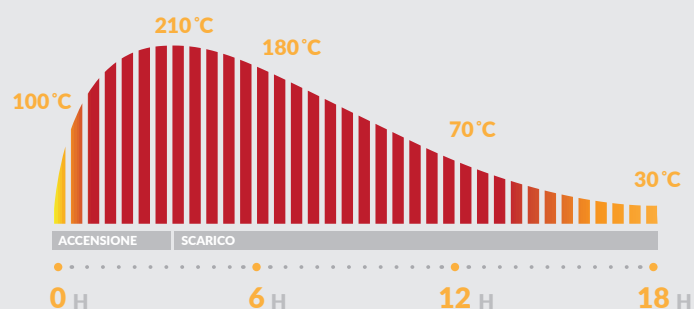



Serie X Plus



STUFE A LEGNA



X Line Plus



Misure (LxPxH)
534x464x1518 mm

   
176/246* 9,5 12,0 15 PP

- Acciaio verniciato Nero

- Sportello inferiore (optional)



* Peso senza e con kit accumulo (70 kg) Durasic® (optional).



X Rock Plus



Misure (LxPxH)
550x462x1536 mm

   
302/372* 9,5 12,0 15 PP

- Pietra Naturale

- Sportello inferiore (optional)

* Peso senza e con kit accumulo (70 kg) Durasic® (optional).

Serie X Plus

STUFE A LEGNA



X Art Plus



Misure (LxPxH)

600x476x1546 mm

273/343*
 9,5
 12,0
 15 PP

- Maiolica
- Sportello inferiore (optional)

* Peso senza e con kit accumulo (70 kg) Durasic® (optional).

Valori contributo Conto termico 2.0.
Riscaldamento a legna. Fonte di grande risparmio.

Modello	kW	A	B	C	D	E	F
X BASIC	9,5 kW	543,01 €	769,27 €	995,52 €	1267,03 €	1538,53 €	1629,03 €

Finiture: pag. 38
Area tecnica: pag. 44

Tecnologie:



Serie X Chef





Cucinare con eleganza

La versione Chef della Serie X è dotata di un ampio forno posto immediatamente sopra la camera di combustione della stufa a legna. L'altezza da terra ne fa un comodissimo e pratico strumento di cottura dalle alte prestazioni. Rivestito interamente in acciaio inox, il forno è dotato di teglia, termometro e porta forno con doppio vetro.

Serie X Chef

STUFE A LEGNA



X Line Chef



Misure (LxPxH)
534x464x1518 mm

Misure forno (LxPxH)
350x320x215 mm

 **KG**  **kW**  **kW_{MAX}**  **mg/m³**
220 9,5 12,0 15 PP

- Acciaio verniciato Nero
- Sportello inferiore (optional)



X Rock Chef



Misure (LxPxH)
550x462x1536 mm

Misure forno (LxPxH)
350x320x215 mm

 **KG**  **kW**  **kW_{MAX}**  **mg/m³**
340 9,5 12,0 15 PP

- Pietra Naturale
- Sportello inferiore (optional)

Serie X Chef

STUFE A LEGNA



X Art Chef



Misure (LxPxH)
600x476x1546 mm

Misure forno (LxPxH)
350x320x215 mm

280
 9,5
 12,0
 15 PP

- Maiolica
- Sportello inferiore (optional)

CARATTERISTICHE FORNO

- Forno in acciaio Inox
- Porta forno con doppio vetro
- Porta forno a chiusura magnetica
- Termometro integrato
- Teglia smaltata
- Temperature omogenee oltre i 300°
- Dimensioni del forno: 350x320x215 mm (LxPxH)



Valori contributo Conto termico 2.0.
Riscaldamento a legna. Fonte di grande risparmio.

Modello	kW	A	B	C	D	E	F
X BASIC	9,5 kW	543,01 €	769,27 €	995,52 €	1267,03 €	1538,53 €	1629,03 €

Finiture: pag. 38
Area tecnica: pag. 44

Tecnologie:



Serie X Living

La stufa a legna componibile

Il sistema X Living prevede un corpo stufa principale e una serie di componenti appositamente coordinati e combinabili a piacere intorno alla camera di combustione. In questo modo le possibilità di arredo aumentano considerevolmente in base al gusto e alle esigenze del cliente.



Serie X Living

STUFE A LEGNA



X Living



Misure (LxPxH)
534x464x805 mm

 120  9,5  12,0  15 PP



Panca

Misure (LxPxH)
1132x464x348 mm



Mobile

Misure (LxPxH)
350x464x1145 mm

Finiture: pag. 38
Esempi di composizione: pag. 35
Area tecnica: pag. 44

Tecnologie:



Crea la tua composizione

Esempio in figura



X living

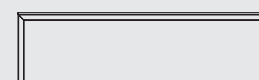

Panca

Esempio in figura



X living

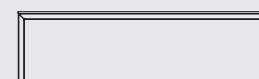

Panca



Mobile

Serie X Vision

STUFE A LEGNA



X Vision



Misure (LxPxH)
534x464x1300 mm

170 KG 9,5 kW 12,0 kW_{MAX} 15 PP
mg/m³

Serie X Dateo

STUFE A LEGNA



X Dateo



Misure (LxPxH)
534x464x1145 mm

145 KG 9,5 kW 12,0 kW_{MAX} 15 PP
mg/m³

Finiture: pag. 38
Area tecnica: pag. 44

Tecnologie:





Colori e finiture

Tutti i modelli della Serie X sono disponibili in diverse finiture e colori.

X Line



Nero
(verniciato)

X Vision



Nero
(verniciato)

X Dateo



Nero
(verniciato)

X Living



Nero
(verniciato)

X Art



Bianco
(rivestimento in maiolica)



Rosso
(rivestimento in maiolica)



Nero opaco
(rivestimento in maiolica)

X Rock



Pietra Naturale
(rivestimento in pietra)



Inserti a legna



Fuoco e design

X 50 V è un inserto moderno costruito con materiali solidi e di pregio concepito per riscaldare in modo sano ed ecologico. La maxi camera di combustione con vetro ceramico autopulente darà il meglio di sé in ogni ambiente, creando una bellissima atmosfera grazie ad una fiamma elegante e rilassante.



Serie X 50 V

INSERTI A LEGNA



X 50 V



Misure (LxPxH)
520x450x827 mm



110



9,5



12,0



15 PP

CARATTERISTICHE PRINCIPALI SERIE X 50 V:

- Corpo ermetico in acciaio
- Graticola cenere rotante in ghisa
- Cassetto cenere estraibile
- Camera di combustione in vermiculite ad alta densità
- Spessore vermiculite 30 mm
- Aria primaria, secondaria e terziaria regolabile
- Uscita fumi superiore e posteriore
- Vetro ceramico da 5 mm con sistema Shiny Glass®
- Maniglie isolate in acciaio verniciato
- Porta fuoco con chiusura automatica di sicurezza
- Presa d'aria esterna - External Air®
- Cornice in acciaio verniciato nero

Area tecnica: pag. 44

Tecnologie:





Area tecnica

Specifiche tecniche

Modelli	Larghezza	Profondità	Altezza	Bocca di carico (lxh)	Dimensioni del forno (lxpxh)	Peso (Kg.)	Potenza nominale (kW)	Potenza massima (kW)	Rendimento a potenza nom. %	Flusso gas di scarico (g/s)	Temp. gas di scarico (C°)(2)	Tiraggio consigliato (Pa)
X Art Basic	600	476	1173	372x350	-	240	9,5	12,0	85,2	8,5	195	12
X Art Plus	600	476	1546	372x350	-	273/343 ⁽¹⁾	9,5	12,0	85,2	8,5	195	12
X Art Chef	600	476	1546	372x350	350x320x215	280	9,5	12,0	85,2	8,5	195	12
X Rock Basic	550	462	1163	372x350	-	275	9,5	12,0	85,2	8,5	195	12
X Rock Plus	550	462	1536	372x350	-	302/372 ⁽¹⁾	9,5	12,0	85,2	8,5	195	12
X Rock Chef	550	462	1536	372x350	350x320x215	340	9,5	12,0	85,2	8,5	195	12
X Line Basic	534	464	1145	372x350	-	175	9,5	12,0	85,2	8,5	195	12
X Line Plus	534	464	1518	372x350	-	176/246 ⁽¹⁾	9,5	12,0	85,2	8,5	195	12
X Line Chef	534	464	1518	372x350	350x320x215	220	9,5	12,0	85,2	8,5	195	12
X Vision	534	464	1300	372x350	-	170	9,5	12,0	85,2	8,5	195	12
X 50 V	520	450	827	372x350	-	110	9,5	12,0	85,2	8,5	195	12
X Dateo	534	464	1145	372x350	-	145	9,5	12,0	85,2	8,5	195	12
X Living	534	464	805	372x350	-	120	9,5	12,0	85,2	8,5	195	12

Misure in mm

(1) Peso senza e con kit accumulo (70 kg) Durasic® (optional).

(2) Temperatura media alla potenza nominale. Si possono avere temperature dei fumi istantanee superiori. Si raccomanda di utilizzare sempre tubazioni con specifica minima T400.

Dotazioni

Modelli

	Presa d'aria esterna - External Air®	Reg. aria primaria, secondaria, terziaria	Sistema di combustione - Superflame®	Porta fuoco con vetro ceramico - Shiny Glass®	Porta fuoco con chiusura autom. di sicurezza	Forno in acciaio inox	Porta forno con doppio vetro e termometro	Piedini livellatori regolabili	Vano porta legna aperto	Sportello vano porta legna	Uscita fumi superiore	Uscita fumi posteriore	Lamiera copripavimento	Sistema ad accumulo Durasic®
X Art Basic	●	●	●	●	●	—	—	●	●	●	●	●	●	—
X Art Plus	●	●	●	●	●	—	—	●	●	●	●	—	●	●
X Art Chef	●	●	●	●	●	●	●	●	●	●	●	—	●	—
X Rock Basic	●	●	●	●	●	—	—	●	●	●	●	●	●	—
X Rock Plus	●	●	●	●	●	—	—	●	●	●	●	—	●	●
X Rock Chef	●	●	●	●	●	●	●	●	●	●	●	—	●	—
X Line Basic	●	●	●	●	●	—	—	●	●	●	●	●	●	—
X Line Plus	●	●	●	●	●	—	—	●	●	●	●	—	●	●
X Line Chef	●	●	●	●	●	●	●	●	●	●	●	—	●	—
X Vision	●	●	●	●	●	—	—	—	—	—	●	●	●	—
X 50 V	●	●	●	●	●	—	—	—	—	—	●	●	●	—
X Dateo	●	●	●	●	●	—	—	—	—	—	●	●	●	—
X Living	●	●	●	●	●	—	—	—	—	—	●	●	●	—

● di serie ● optional — non disponibile

Uscita fumi Serie X

Modelli	A	B	C	D	ø
X Art Basic	1020	300	185	300	150
X Art Plus	-	-	185	300	150
X Art Chef	-	-	185	300	150
X Rock Basic	1020	277	195	277	150
X Rock Plus	-	-	195	277	150
X Rock Chef	-	-	195	277	150
X Line Basic	1020	267	195	267	150
X Line Plus	-	-	195	267	150
X Line Chef	-	-	195	267	150
X Vision	1180	267	195	267	150
X 50 V	689	260	260	270	150
X Dateo	1018	267	267	270	150
X Living	677	267	267	270	150

Misure in mm

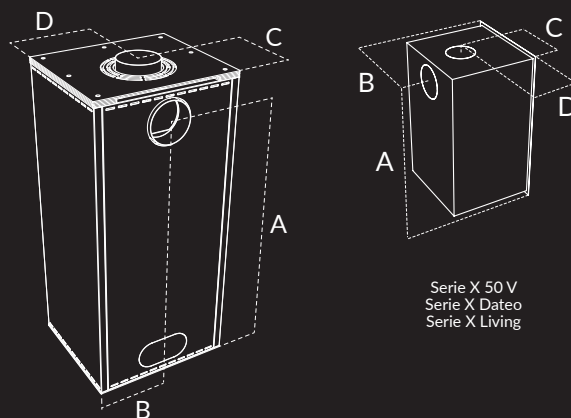

Serie X

Serie X 50 V
Serie X Dateo
Serie X Living

Preso d'aria esterna Serie X

Modelli	A	B	C	D	F	H	ø
X Art Basic	95	210	110	300	111	388	75
X Art Plus	95	210	110	300	111	388	75
X Art Chef	95	210	110	300	111	388	75
X Rock Basic	95	210	110	275	120	388	75
X Rock Plus	95	210	110	275	120	388	75
X Rock Chef	95	210	110	275	120	388	75
X Line Basic	95	210	110	267	120	388	75
X Line Plus	95	210	110	267	120	388	75
X Line Chef	95	210	110	267	120	388	75
X Vision	95	110	110	267	83	543	75
X 50 V	84	-	210	260	69	56	75
X Dateo	-	-	-	267	83	383	75
X Living	-	-	-	267	83	44	75

Misure in mm

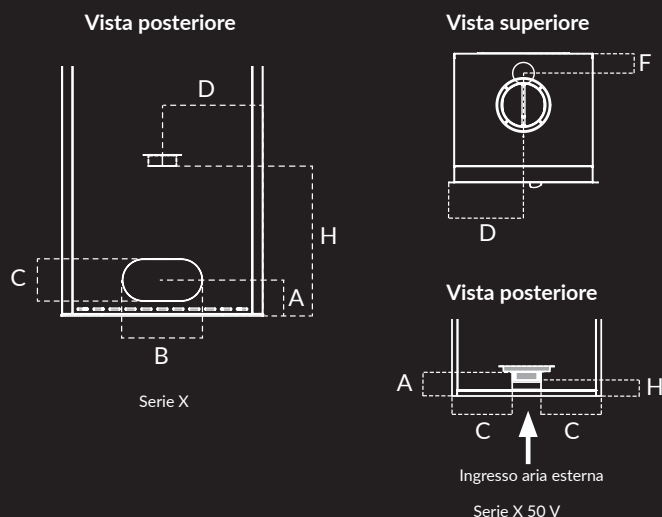

Vista superiore

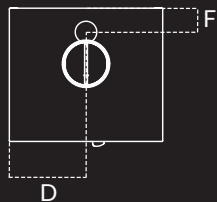

Vista posteriore

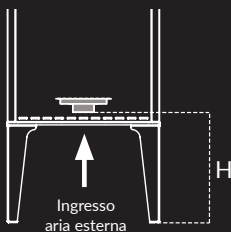

Serie X Dateo

Vista superiore

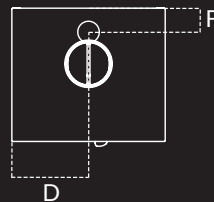

Serie X Living

Vista posteriore



La grande famiglia Rizzoli

CUCINE A LEGNA



Serie R



Serie S



Serie M



Serie L



Serie ZVI



Serie N

TERMOCUCINE A LEGNA



Serie RT



Serie ST



Serie STP



Serie LT

PROFESSIONALI



Serie PRO



Serie PRO Termo

A MISURA



Serie PE

MONOBLOCCHI



CUCINE COMBinate



AG GRILL



AG Grill

CAPPE ASPIRANTI



MOBILI IN ACCIAIO



PENSILI IN ACCIAIO



TERMOSTUFE A LEGNA



Serie T Basic



Serie T Chef

STUFE A LEGNA



Serie X Basic



Serie X Plus



Serie X Chef



Serie X Vision



Serie X Living



Serie X 50 V

INSERTI A LEGNA

Visita il nostro sito: www.rizzolicucine.it

Rizzoli è costantemente orientata al miglioramento dei propri prodotti. Per questo motivo, caratteristiche tecniche ed estetiche del presente catalogo potranno subire variazioni senza preavviso.



Rizzoli srl / Unica sede
Zona Artigianale, 1 / Frazione San Lugano
39040 Trodena nel Parco Naturale (BZ) Italia
ph +39 0471 887551 / info@rizzolicucine.it / www.rizzolicucine.it

